

# Core 4" Square Dual Head Adjustable Downlight (102mm)

Formerly known as 1009M-2, 1012M-2 and 1017M-2  
Adjustable Recessed Accent Light

## The Core Family

Welcome to the Core line of fixtures. The family is filled with a rich diversity of options while keeping classic forms. This family member features two adjustable heads deployed within a single square optical aperture of your choosing. The unique configuration allows down and accent lighting with 360° rotation and 45° tilt within a single ceiling element. With multiple source, driver, control, mounting and finish options, including wood trim, you should find the option you are looking for. If not, let us know the modification you need, we usually say YES.

PROJECT:

TYPE:

SPECIFIER:

DATE:

### Key Points (CR4MD-SDH)

#### Trim

- Flanged or Flangeless
- One-piece die cast aluminum or machined wood trim
- 14 color options + custom RAL or wood available
- Flangeless plaster mounting includes plaster flange with lip

#### Source / Optics

- Lifetime: L87B3>55,000 hours at 40°C Ambient
- 2700, 3000, 3500, 4000K, Ambient Dim standard. Tunable White or RGBW available upon request
- 90 CRI, 60+ R9 Standard- 95 CRI 90+R9 available with Ambient Dim
- <2 MacAdam Steps (<2SDCM) for fixed white
- Up to 1068 delivered lumens from a single head
- Adjustable to 45° with 358° of rotation for both heads
- 4 beamspreads available- 15°, 24°, 40°, and 55°

#### Housing

- Compliant to with Airtight Housing
- Listed – Damp or wet with shower trim
- Approved for 8 (4-in / 4-out) #12 AWG conductors rated for 90°C through wiring
- IC Rated / Airtight Housing approved for use in direct contact with insulation – Chicago Plenum Available
- Heavy gauge aluminum for new construction or remodel

#### Driver

- Phase, 0-10, DALI, Ecosystem or Wireless Control
- Flicker free to IEEE 1798-2015
- Prewired and integral to housing
- Universal 120-277v unless otherwise noted

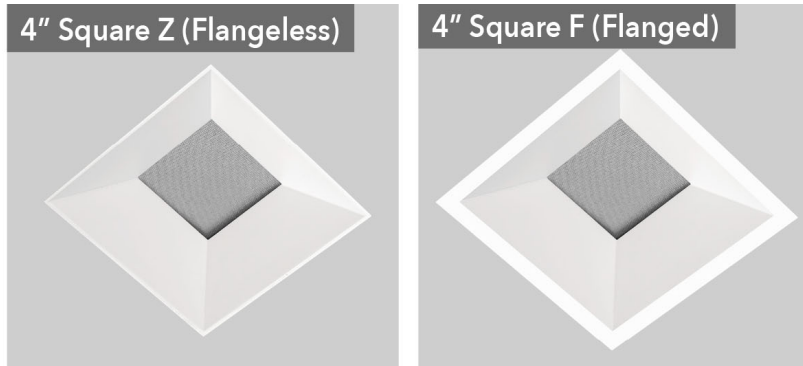

Deep Regress Shown

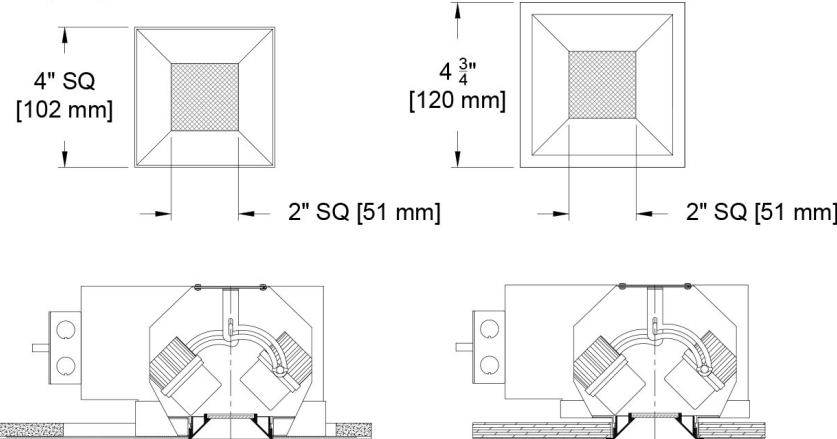

### Aperture Options

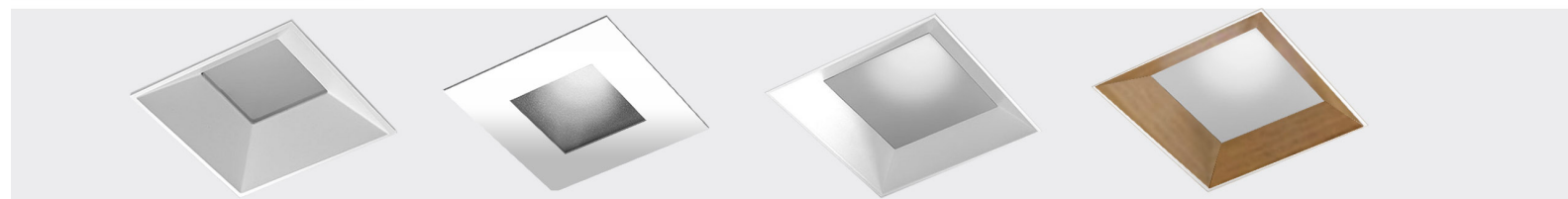

Deep Regress (DR)  
2" Optical Aperture  
Formerly known as 1009M-2

FL- Flat (Pin Hole)  
2" Optical Aperture  
Formerly known as 1012M-2

Open Regress (OR)  
3" Optical Aperture  
Formerly known as 1017M-2

Wood Finish  
All apertures options

SQUARE Beamspreads		15°				24°				40°				55°			
Source	System watts (W)	Delivered Lumens (lm)	Lumens/Watt	Peak CD	10% Field	Delivered Lumens (lm)	Lumens/Watt	Peak CD	10% Field	Delivered Lumens (lm)	Lumens/Watt	Peak CD	10% Field	Delivered Lumens (lm)	Lms/Watt	Peak CD	10% Field
Citizen C14	15	1068	71	7642	42°	995	66	4174	46°	1037	69	3429	51°	996	66	1402	71°
Ambient Dim A14	15	694	46	6220	43°	656	44	3189	44°	656	44	1827	53°	643	43	1028	70°

All Measurements delivered or derived delivered lumens based on 3000k with Deep Regress. Data is based on a single head. Dual heads will deliver more light depending on aim. Ambient dim at full output.

# Core 4" Square Dual Head Adjustable Downlight (102mm)

Formerly known as 1009M-2, 1012M-2 and 1017M-2

Adjustable Recessed Accent Light



## Ordering Codes

PROJECT:

SPECIFIER:

DATE:

TYPE:

QUANTITY:

Ordering Code Example: CR4MD-SDH-DR-Z-AU-A14-AD-24-E2-2C-P16-92A-91L-97L-CP

FIXTURE	APERTURE	TRIM	MOUNTING	SOURCE / WATTS	CCT	BEAM	DRIVER / CONTROL	CIRCUITS	TRIM FINISH	LENS ACCESSORIES	ACCESSORIES
CR4MD-SDH											
Core 4" Square Dual Head Adjustable Downlight	DR Dual Head Deep Regress OR Dual Head Open Regress FL Dual Head Flat (Pin Hole)	F Flanged Trim Z Flangeless Trim FS Flanged Shower Trim* ZS Flangeless Shower Trim* * Aperture Lens Required	U Universal - Non IC Housing AU Universal IC/Airtight P Plaster AP Plaster IC/Airtight PM Panel Mount APM Panel Mount Airtight/IC California Title Compliant Note: Selection of EldoLED or Lutron driver requires a larger housing - see drawings	<b>Citizen</b> C14 15W 995Lm** 90+CRI, 60+R9 <b>Ambient Dim</b> A14 15W 656Lm** 95+CRI, 90+R9 3000 to 1900K <b>INK</b> Tunable White 90+CRI, 70+R9 1800-4000K or 2700-6500K^ RGBW 90+CRI, 60+R9 ^ California Title 24 Compliant to JA8 ** Based on Single Head Deep Regress 24° beam ^ Available upon request. Contact your regional sales manager	27 2700K 30 3000K 35 3500K 40 4000K AD 3000-1900K	15 Spot 24 Narrow Flood 40 Flood 55 Wide Flood	C1 0-10 1.0%, UNV (120-277V) linear C2 ELV/Triac 1.0%, (120V) linear <b>EldoLED</b> E1 0-10* 0.1%, UNV (120-277V) log E2 DALI-2 0.1%, UNV (120-277V) log E3 0-10* 0.1%, UNV (120-277V) linear <b>Lutron</b> LD Digital Ecosystem* 1.0%, UNV (120-277V) ECO Hi-Lume SoftOn/Fade-to-Black LDE1 LP Digital Ecosystem* 0.1%, UNV (120-277V) ECO Premier Hi-Lume SoftOn/Fade-to-Black, PEQ0, 20W max *Requires larger housing - see drawings	1C 1 Circuit 2C 2 Circuit	W White Paint B Black Paint D Wood* PXX Specialty Paint Color* P01-P15 C Custom/RAL Color** *Refer to wood trim guide **See Specialty Finish Guide FINISH GUIDE LINK WOOD TRIM GUIDE	Aperture Lens 91A Solite 93A Frosted XXA Other Aperture Lens Treatments* Reflector (lamp) Media 91L Solite 93L Frosted 97L Black Hexcel Louver XXL Other reflector (lamp) media* 1 piece of media per opening (aperture or reflector) can be selected * Refer to Lens Accessory Guide LENS ACCESSORY VISUAL GUIDE LINK	CP Chicago Plenum EM Emergency Pack EMP Emergency Pack with phase cut control system utilizing C1 driver Controls LR Lutron Wireless RF PowPak ATH Lutron Athena Wireless Node <i>Must be used with E2 driver</i> CA Casambi Wireless BLE to be paired with driver

# Core 4" Square Dual Head Adjustable Downlight (102mm)

Formerly known as 1009M-2, 1012M-2 and 1017M-2

Adjustable Recessed Accent Light

## Ceiling Cutouts and Dimensions

Deep Regress Shown - others similar

A Lutron or Eldoled driver selection requires a larger housing to accommodate packaging, wiring and service of "K-can" size driver. See next page for other mounting options and drawings

### Square Flangeless Housing

Plaster Mount (P/AP)

C1 or C2 Driver

(CR4MD-SDH-DR-Z-P/AP)

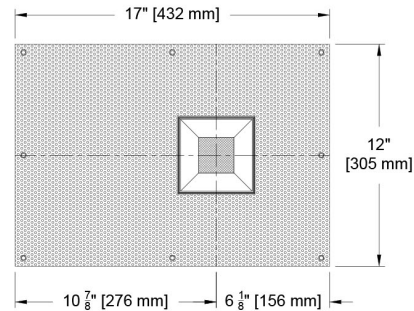
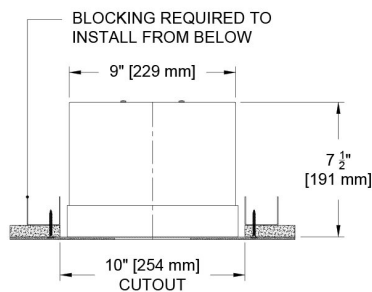
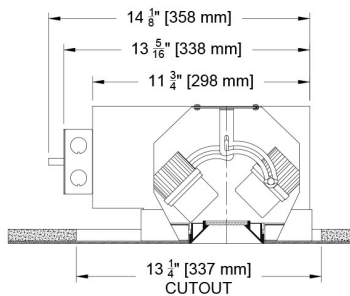

### Square Flangeless Housing

Plaster Mount (P/AP)

Lutron or Eldo Driver

(CR4MD-SDH-DR-Z-P/AP)

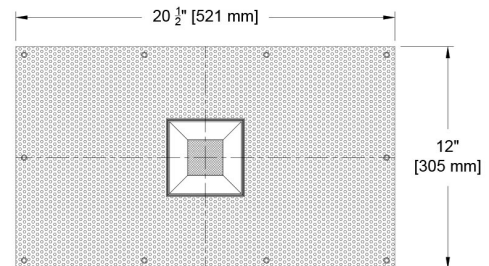
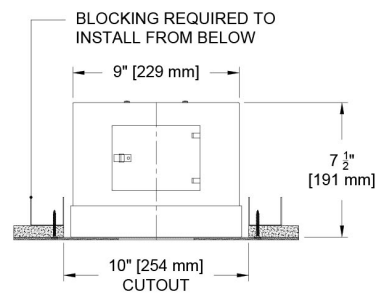
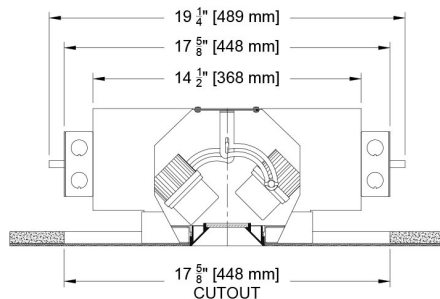

# Core 4" Square Dual Head Adjustable Downlight (102mm)

Formerly known as 1009M-2, 1012M-2 and 1017M-2  
Adjustable Recessed Accent Light

## Ceiling Cutouts and Dimensions

Deep Regress Shown - others similar

### Square Flanged Housing

### Flanged Mount (U/AU)

(CR4MD-SDH-DR -F-U/AU)

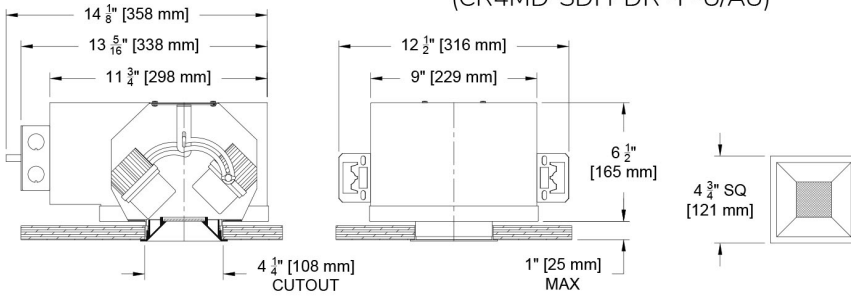

### Square Flangeless Housing

### Flangeless Mount (U/AU)

(CR4MD-SDH-DR -Z-U/AU)

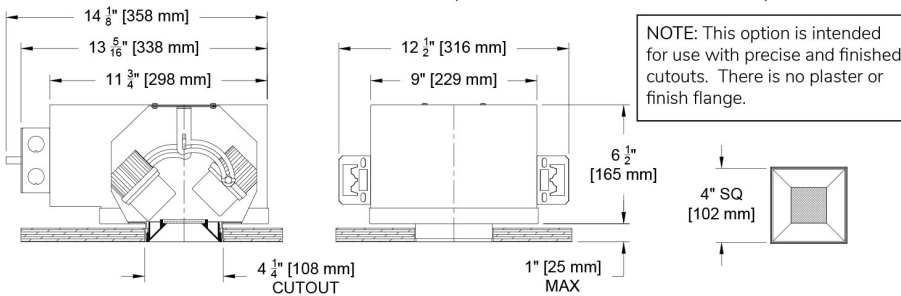

### Square Flangeless Housing

### Panel Mount (PM/APM)

(CR4MD-SDH-DR -Z-PM/APM)

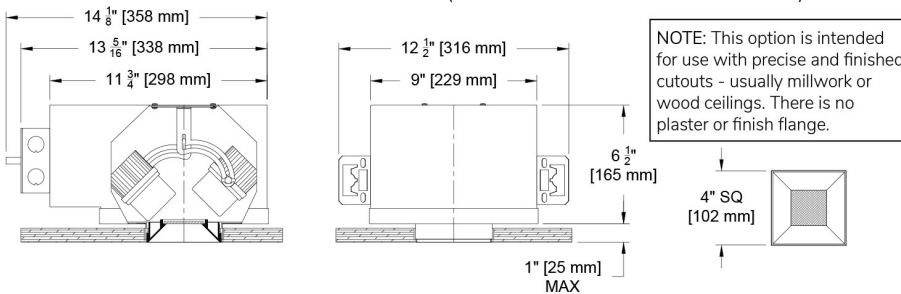

### Hanger Bar Detail

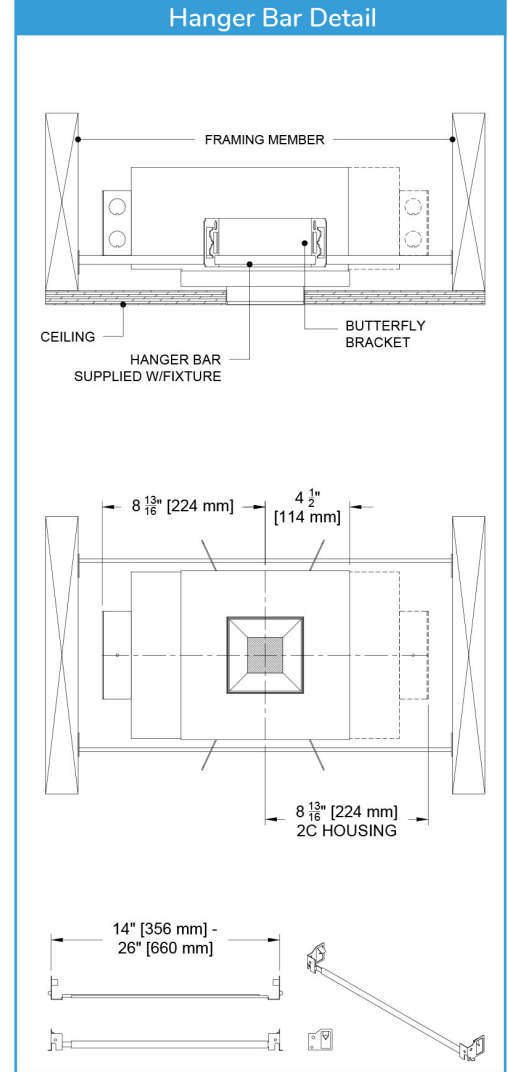

### Housing Detail- EldoLED / Lutron Driver Selection

(CR4MD-SDH-\_-\_-C14-30-24)

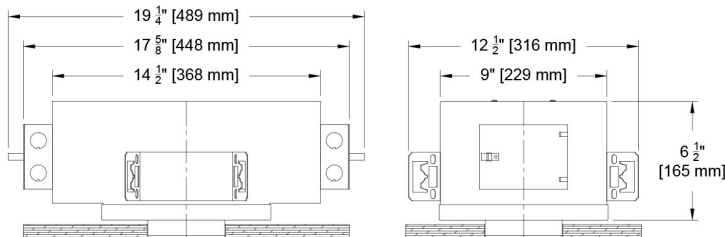

### Panel Mount Detail

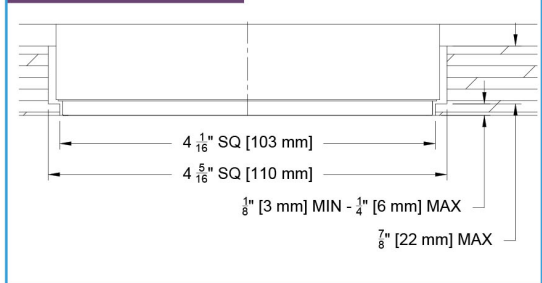

# Core 4" Square Dual Head Adjustable Downlight (102mm)

Formerly known as 1009M-2, 1012M-2 and 1017M-2  
Adjustable Recessed Accent Light



## Photometric Table

Photometric values are based on a single head fixture. Multiple heads will deliver additional light and will need to be accounted for individually in calculations. All data is based from goniometer measurements of production representative product. All lumen values are delivered or derived and can vary +/- 10% from LED manufacturer rated flux range. Measurements at 3000 CCT and Ambient Dim at full output. Due to thermal and space considerations, our maximum power is 15 system watts. If higher lumen packages are desired in this configuration, contact your Regional Sales Manager for a custom request.

SQUARE Beamspreads		15°				24°				40°				55°				
Source	System watts (W)	Delivered Lumens (lm)	Lumens/Watt	Peak CD	10% Field	Delivered Lumens (lm)	Lumens/Watt	Peak CD	10% Field	Delivered Lumens (lm)	Lumens/Watt	Peak CD	10% Field	Delivered Lumens (lm)	Lms/Watt	Peak CD	10% Field	
Deep Regress	Citizen C14	15	1068	71	7642	42°	995	66	4174	46°	1037	69	3429	51°	996	66	1402	71°
	Ambient Dim A14	15	694	46	6220	43°	656	44	3189	44°	656	44	1827	53°	643	43	1028	70°
Open Regress	Citizen C14	15	1173	78	7776	42°	1091	73	4167	52°	1112	74	2422	66°	1058	71	1357	74°
	Ambient Dim A14	15	810	54	5857	39°	779	52	3270	56°	779	52	1829	60°	764	51	1058	72°
Flat (Pin Hole)	Citizen C14	15	829	55	7740	37°	737	49	1436	46°	719	48	2379	51°	661	44	1357	64°
	Ambient Dim A14	15	539	36	4828	36°	479	32	2326	42°	467	31	1301	50°	429	29	689	63°
CCT Multiplier																		
CCT	Citizen																	
2700	0.95																	
3000	1.00																	
3500	1.02																	
4000	1.03																	
All measurements based on 3000 CCT.																		

All Measurements delivered or derived delivered lumens based on 3000K. ISO CD plots based on Open Regress. Data is based on a single head. Dual heads will deliver more light depending on aim. Ambient dim at full output. Flat (Pin Hole) at wider beam angles experience significant beam clipping - refer to PDF report for exact FWHM beam angle.

# Color Data

All data is based from goniometer measurements of production representative product. All lumen values can vary +/- 10% from LED manufacturer rated data range. Measurements at 3000 CCT unless otherwise noted

## Citizen Source C14, C20 and C28

### Citizen CoB

- <2 MacAdam Ellipse (<2 SDCM)
- 90+ CRI and RF
- 60+R9, Hue Bin 1

92 CRI    69 R9

89 RF    103 RG

CRI: 92.4 (R1-R8)

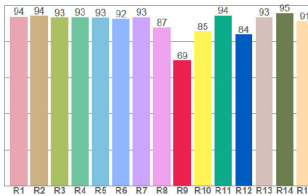

TM30: 89.2

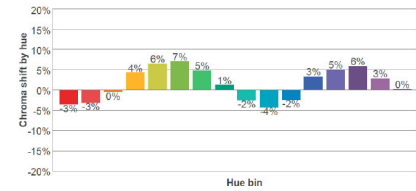
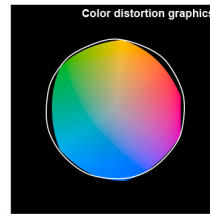
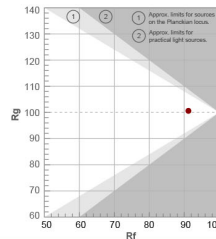
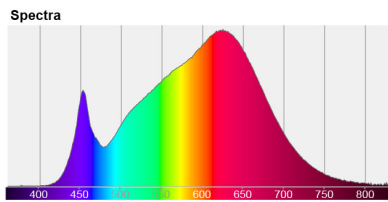
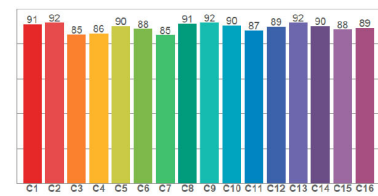

## Ambient Dim - 3000k to 1900k

- <3 MacAdam Ellipse (<3 SDCM)
- 95+ CRI and RF
- 90+R9, Hue Bin 1
- Follows Black Body Locus through dimming range

### 3000 CCT Full Output

97 CRI    98 R9    95 RF    104 RG

Spectra

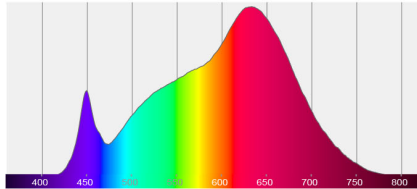

CRI: 96.9 (R1-R8)

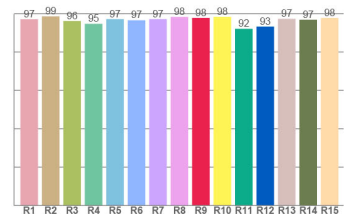

### 1850 CCT 5% Output

93 CRI    72 R9    83 RF    110 RG

Spectra

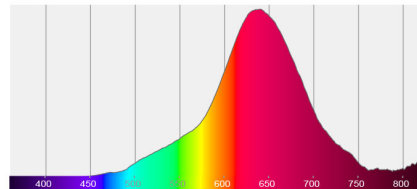

CRI: 92.6 (R1-R8)

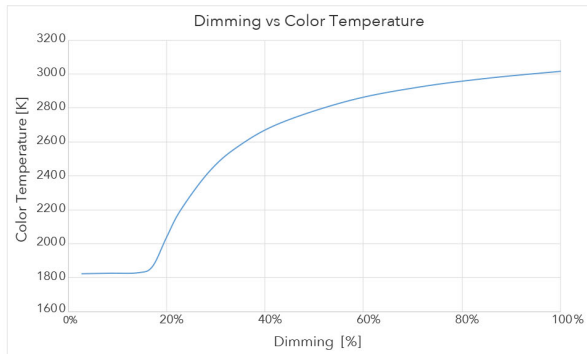
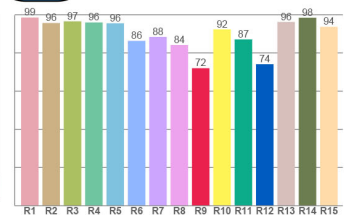

## Core 4" Square Dual Head Adjustable Downlight (102mm)

Formerly known as 1009M-2, 1012M-2 and 1017M-2

Adjustable Recessed Accent Light



## Tunable White and RGBW

Color and flux information available upon request